

DE-STARLITE - A Directed Energy Planetary Defense Mission

Kelly Kosmo^a, Mark Pryor^b, Philip Lubin^a, Gary B. Hughes^c, Hugh O'Neill^d, Peter Meinhold^a, Jonathon Suen^a, Jordan Riley^a, Janelle Griswold^a, Brianna Vail Cook^a, Isabella E. Johansson^a, Qicheng Zhang^a, Kevin Walsh^e, Carl Melis^f, Miikka Kangas^a, Johanna Bible^a, Caio Motta^a, Travis Brashears^a, Shana Mathew^a and Justin Bollag^a.

lubin@deepspace.ucsb.edu

kellykosmo@gmail.com

^aPhysics Department, University of California, Santa Barbara, CA 93106

^bVorticity Inc, San Diego, CA 92121

^cStatistics Department, California Polytechnic State University, San Luis Obispo, CA 93407

^dPhysics Department, California Polytechnic State University, San Luis Obispo, CA 93407

^eSouthwest Research Institute, Boulder, CO 80302

^fCenter for Astrophysics and Space Sciences, UC San Diego, San Diego, CA 92093

ABSTRACT

This paper presents the motivation behind and design of a directed energy planetary defense system that utilizes laser ablation of an asteroid to impart a deflecting force on the target. The proposed system is called **DE-STARLITE** for **Directed Energy System for Targeting of Asteroids and ExploRation** – LITE as it is a small, stand-on unit of a larger standoff DE-STAR system. Pursuant to the stand-on design, ion engines will propel the spacecraft from low-Earth orbit (LEO) to the near-Earth asteroid (NEA). During laser ablation, the asteroid itself becomes the "propellant"; thus a very modest spacecraft can deflect an asteroid much larger than would be possible with a system of similar mission mass using ion beam deflection (IBD) or a gravity tractor. DE-STARLITE is capable of deflecting an Apophis-class (325 m diameter) asteroid with a 15-year targeting time. The mission fits within the rough mission parameters of the Asteroid Redirect Mission (ARM) program in terms of mass and size and has much greater capability for planetary defense than current proposals and is readily scalable to the threat. It can deflect all known threats with sufficient warning.

Keywords: DE-STAR, DE-STARLITE, Directed Energy, Laser Phased Array, Planetary Defense

1. INTRODUCTION

While implementing a directed energy planetary defense system may have seemed preposterous as little as a decade ago, recent technological developments allow serious consideration of such a system. The critical items such as phase locked laser amplifiers and lightweight photovoltaic deployable arrays are becoming increasingly more efficient and lower in mass. The necessary technology now exists to fulfill the need for planetary defense against asteroids that pose a threat of impacting Earth.

This paper proposes a design for a stand-on directed energy planetary defense system called **DE-STARLITE**, which will serve as a critical step towards implementing a future orbiting stand-off directed energy system called DE-STAR, for **Directed Energy System for Targeting of Asteroids and exploRation**. Fluctuations in the Earth's atmosphere significantly hinder ground-based directed energy systems; thus, deploying a directed energy system above Earth's atmosphere eliminates such disturbances, as the interplanetary medium is not substantial enough to significantly affect the coherent beam. DE-STARLITE is a "stand-on" system designed to be taken to the threatening asteroid with a modest spacecraft and then work slowly on the threat to change its orbit. DE-STARLITE is suitable for mitigating targets that are many hundreds of meters in diameter and whose orbit is known to be a threat long before projected impact.

Residents near Chelyabinsk, Russia experienced the detrimental effects of a collision with a near-Earth asteroid (NEA) on 15 February 2013 as a ~20 m object penetrated the atmosphere above that city. The effective yield from this object was approximately 1/2 Megaton TNT equivalent (Mt), or that of a large strategic warhead. The 1908 Tunguska event, also over Russia, is estimated to have had a yield of approximately 15 Mt and had the potential to kill millions of people had it come down over a large city¹. Asteroid impacts pose a clear threat to modern civilization and ensuring

humanity's continuity and future advancement requires effective mitigation strategies. DE-STAR is a series of modular stand-off directed energy planetary defense systems designed to mitigate the potential hazards posed by asteroids and comets whose trajectory crosses Earth's orbital path. DE-STARLITE is a smaller stand-on unit of DE-STAR, designed to approach and to deflect a specific target. The DE-STARLITE mission design, which will be detailed in this paper, utilizes the same technologies and laser system as the larger standoff directed energy system. Namely, it is a modular phased array of lasers that heat the surface of potentially hazardous asteroids to approximately 3,000 K, a temperature sufficient to vaporize all known constituent materials. Mass ejection due to vaporization causes a reactionary force large enough to alter the asteroid's orbital trajectory and thus mitigate the risk of impact. Each DE-STAR system is characterized by the log of its linear size². DE-STARLITE is basically a DE-STAR 0, consisting of a laser phased array on the order of 1 m in diameter. DE-STARLITE utilizes deployable photovoltaic arrays to power the system. A conceptual system diagram is shown in Fig. 1.

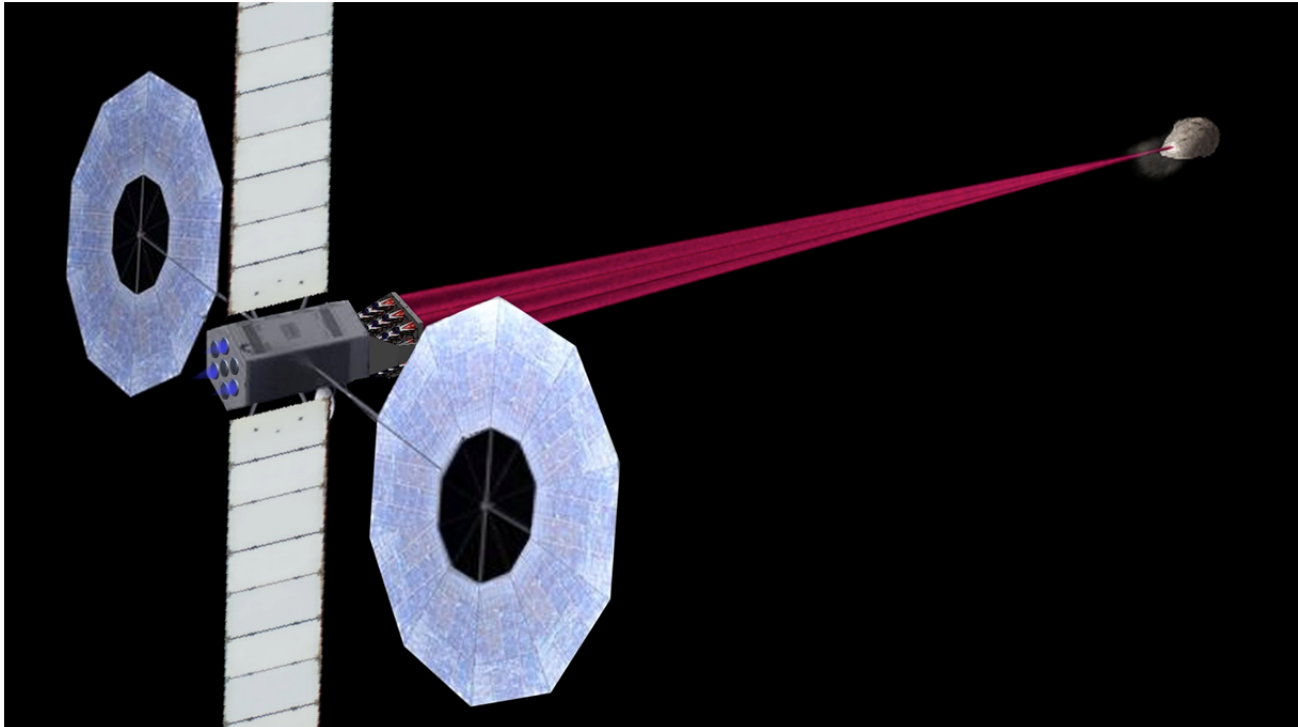

Figure 1. Artistic rendering of a deployed DE-STARLITE spacecraft deflecting an asteroid. The spacecraft is outfitted with two 15 m diameter MegaFlex PV Arrays, a z-folded radiator deployed up and down, a laser array mounted on a gimbal at the front, and ion engines at the back.

DE-STARLITE fits into the same basic launch vehicle and mass envelope as the current Asteroid Redirect Mission (ARM) block 1 program, which is designed to capture a 5-10 m diameter asteroid; however, DE-STARLITE is designed to be a true planetary defense system capable of redirecting large asteroids. It has been designed to use the same ion engines as the ARM program and the same PV system, though due to the reduced mass of DE-STARLITE, a much larger PV array can be deployed within the block 1 mass allocation (14 tons to LEO) if desired. It is a feasible and fundable option that could pave the way for the ultimate long-term goal of a full standoff planetary defense system. This paper details the design of the main elements of the spacecraft, namely, the photovoltaic panels, ion engines, laser array, and radiator as well as the parameters of the launch vehicles under consideration, and details the deflection capabilities of the system.

2. DESIGN

The objective is to design a system that will enable a spacecraft with a 1 m to 4.5 m diameter laser phased array to arrive at an NEA (Near Earth Asteroid) and deflect it from its potentially hazardous trajectory. The laser phased array

is detailed in section 2.3, along with a lower risk potential fallback—a close packed focal plane array of fiber lasers. The DE-STARLITE mission is made possible with a high-power solar electric propulsion (SEP) system¹¹. The solar PV arrays, detailed in Section 2.1, convert power from the sun to provide system power. PV panels will originally be stowed for launch and will deploy upon reaching low-Earth orbit to provide a required 100 kW electrical power from two 15 m diameter ATK MegaFlex panels. Even larger power is possible within the launch mass and shroud sizes available. The system will utilize ion engines (detailed in section 2.2) to propel the spacecraft from LEO to an NEA, as proposed in JPL’s ARM program. The system aims to stay within the same mass and launch constraints as ARM and use much of the same propulsion technology. The laser efficiency determines the laser power obtained from the PV arrays; 35 kW of laser power would be produced at 35% efficiency, 50 kW at 50%, and 70 kW at 70%. The 35 kW estimate is based on the current efficiency (35%) of existing technology of the baseline Ytterbium laser amplifiers and thus provides for the worst case, while the 50 and 70 kW estimates are based on feasible technological improvement within the next 5-15 years. For example, 50% efficiency looks readily achievable within less than 5 years. A passive cooling radiator with z-folded arrays will be used to reject waste heat and maintain the temperature at an operational 300 K.

The basic design principle is to utilize a cylindrical bus with the lateral center of gravity close to the centerline³. PV panels will be stowed at the back of the bus until deployment, and the hexagonal laser array will be mounted on a gimbal at the front of the spacecraft. Radiator panels will deploy up and down (perpendicular to the bus) and will rotate about their axis so as to remain perpendicular to the sun in order to maximize radiator efficiency. Ion engines are located at the back of the spacecraft. Critical components are outlined in sections 2.1 – 2.4.

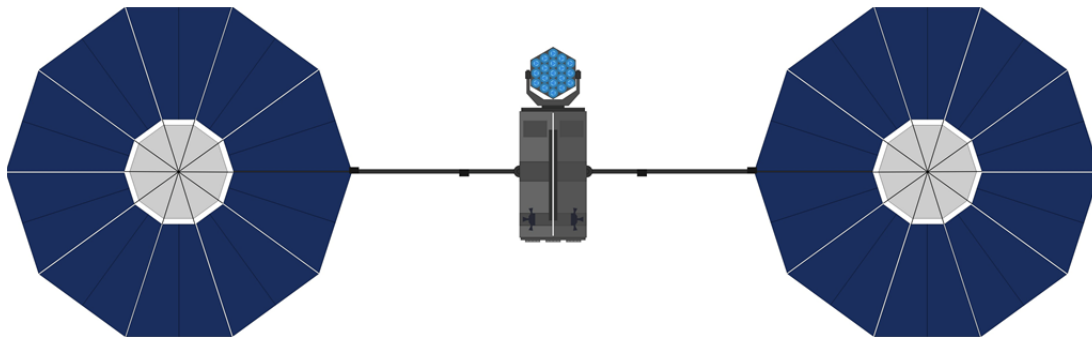

Figure 2. Conceptual design of the deployed spacecraft with two 15 m PV arrays that produce 50 kW each at the beginning of life for a total of 100 kW electrical, ion engines at the back, and the laser array pointed directly at the viewer. A 2 m diameter laser phased array is shown with 19 elements, each of which is 1-3 kW optical output. A 2 m diameter optical system is one of the possibilities for DE-STARLITE. More elements are easily added to allow for scaling to larger power levels. A 1 - 4.5 m diameter is feasible; no additional deflection comes from the larger optic, just additional range from the target.

2.1 Photovoltaic Panels

Two 15 m diameter MegaFlex PV arrays, manufactured by ATK Aerospace Systems in Goleta, CA, will be used to obtain the desired 100 kW power solution. Each array produces 50 kW at their beginning of life (BOL). MegaFlex is a flexible blanket solar array that unfolds in an accordion-like manner. It is composed of lightweight, triangular-shaped, interconnected components that are outfitted with photovoltaic solar cells. The PV arrays will be outfitted with 33.7% efficiency inverted metamorphic multi-junction solar cells from Emcore⁴. Engineers at ATK estimate these solar cells to be commercially available within two years. The MegaFlex PV arrays are a developing technology that will enable a high-power mission as they offer a large deployed area, low mass, compact stowage, and high strength and stiffness. Extensive testing has been conducted on MegaFlex technology and the MegaFlex arrays have a high TRL⁵.

The arrays are folded and stowed as a flat-pack during launch in a very efficient manner. A spar pivot reduces the stowed length, allowing for a far more efficient design than the previous UltraFlex technology. The stowed length of a MegaFlex PV array is 2/3 of the wing radius, giving a stowed length of 5 m for a 15 m diameter wing. Thus, the 15 m diameter MegaFlex panels will have a stowed length of 5 m, which will fit within the parameters of any of the launch vehicles under consideration for this mission. The launch vehicle parameters are detailed in section 3.2. The deployed area of a MegaFlex array is given as $2\pi L^2$, where L is the stowed length. This results in a total deployed area of ~314

m² between the two 15 m diameter arrays. The mass per unit of power for the MegaFlex PV arrays, including the deployment system, is approximately 7 kg/kW, giving a mass of 700 kg for the 100 kW system. This is an exceedingly low mass for 100 kW, which allows for scaling to much higher power levels as needed⁵. Since the laser array is modular, high power is readily achieved if needed by using multiple 15 m arrays, though arrays up to 30 m diameter appear feasible.

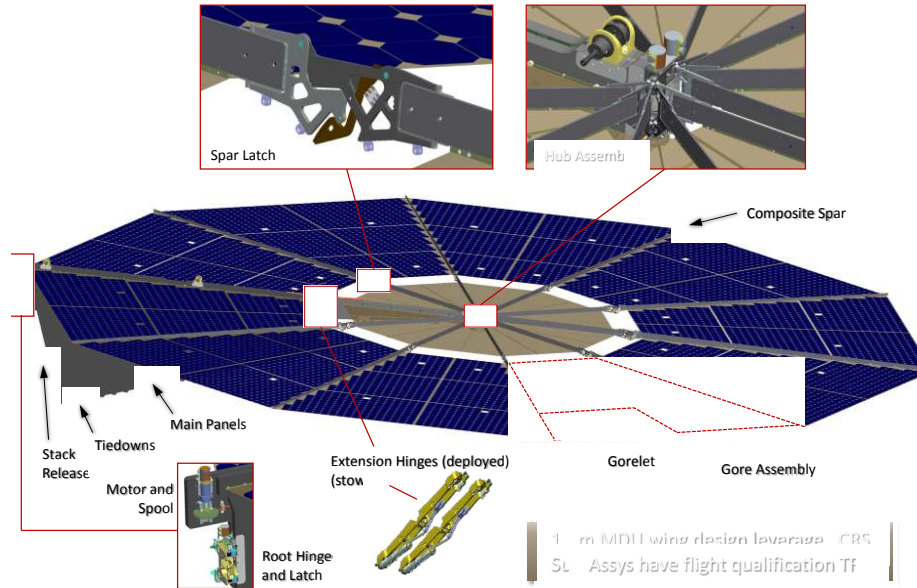

Figure 3. Detailed design of deployed MegaFlex array. Image courtesy ATK.⁵

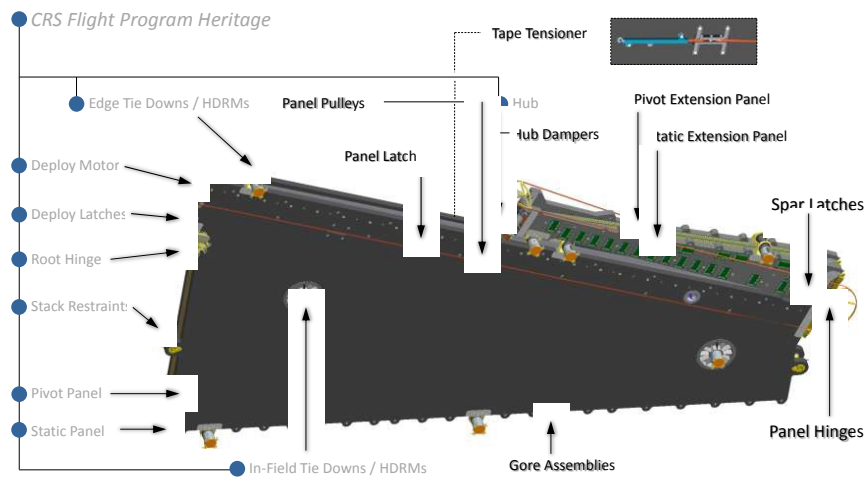

Figure 4. Detailed design of stowed MegaFlex array. Image courtesy ATK.⁵

2.2 Ion Engines

The spacecraft will utilize ion propulsion to spiral out from LEO to its target. The ion engines create electrical propulsion for the spacecraft by accelerating ions to create thrust. Ion engines are proposed for DE-STARLITE because they are between five and ten times more efficient than engines using conventional chemical propellants, depending on the type of ion engine. Xenon will be used to fuel the engines, as is the baseline for ARM. Magnetically shielded Hall effect thrusters, which are proposed for the ARM spacecraft, have a specific impulse (I_{sp}) of 3000 s, translating to an exhaust velocity of Xenon of 30 km/s. Gridded ion thrusters can have an I_{sp} of approximately 6000 s, translating to an

exhaust velocity of 60 km/s. In contrast, the exhaust velocity of H₂O₂ is only ~6 km/s. Ion engines enable shorter flight times and can last longer than chemical engines given the same mass of fuel.

Gridded ion thrusters would be suitable for a dedicated IBD mission, though the magnetically shielded Hall effect thrusters may be more practical for DE-STARLITE to spiral out from LEO to the target. With a higher I_{sp}, the gridded ion thrusters require a smaller mass of fuel than do the Hall effect thrusters to produce a given delta V, though they also require greater power to produce the same thrust. Magnetically shielded Hall effect thrusters, as proposed for ARM, have a coupling efficiency (N/W) of 40 μN/W_{elec}, or conversely, 25 kW_{elec}/N, where W_{elec} refers to electrical input⁶. In contrast, the gridded ion thrusters with an I_{sp} of 6000 s have a thrust to power ratio of approximately 20 μN/W_{elec}, or approximately 50 kW/N. Thus 100 kW of electrical input translates to 4N of thrust if utilizing the Hall thrusters, or approximately 2 N of thrust if utilizing the gridded ion thrusters. The decision, therefore, is dependent on the most efficient way to optimize mass versus power. The PV arrays will provide power to ionize the Xenon atoms to form a plasma. This current interacts with an applied magnetic field perpendicular to the chamber walls to produce an electric field nearly parallel to the walls, and ions are propelled out the exhaust opening to provide thrust. Previously, issues of erosion arose if any component of the electric field ran parallel to the magnetic field, as this would accelerate ions into the chamber walls as opposed to the exhaust opening. However, NASA’s Jet Propulsion Laboratory has improved the issue of erosion in ion engines by shaping the magnetic field so as to protect the engine walls from continually being hit by ions, thus allowing for longer duration missions.

2.3 Laser Array

The objective of the laser directed energy system is to project a large enough flux onto the surface of a near-Earth asteroid (via a highly focused coherent beam) to heat the surface to a temperature that exceeds the vaporization point of constituent materials, namely rock, as depicted in Fig. 5. This requires temperatures that depend on the material, but are typically around 2,000-3,000 K, or a flux in excess of 10⁷ W/m². A reactionary thrust due to mass ejection will divert the asteroid’s trajectory⁷. To produce a great enough flux, the system must have both adequate beam convergence and sufficient power. From a distance of 10 km, a spot size on the asteroid of 10 cm provides enough flux to vaporize (sublimate) rock⁸. Optical aperture size, pointing control and jitter, and efficacy of adaptive optics techniques are several critical factors that effect beam convergence. As mentioned, the optical power output of the laser is projected to be between 35 kW and 70 kW, depending on technological advancements in the coming years. Any of these power levels work for the purpose of this mission, but higher efficiency allows for more thrust on the target for a given electrical input as well as for smaller radiators and hence lower mission mass.

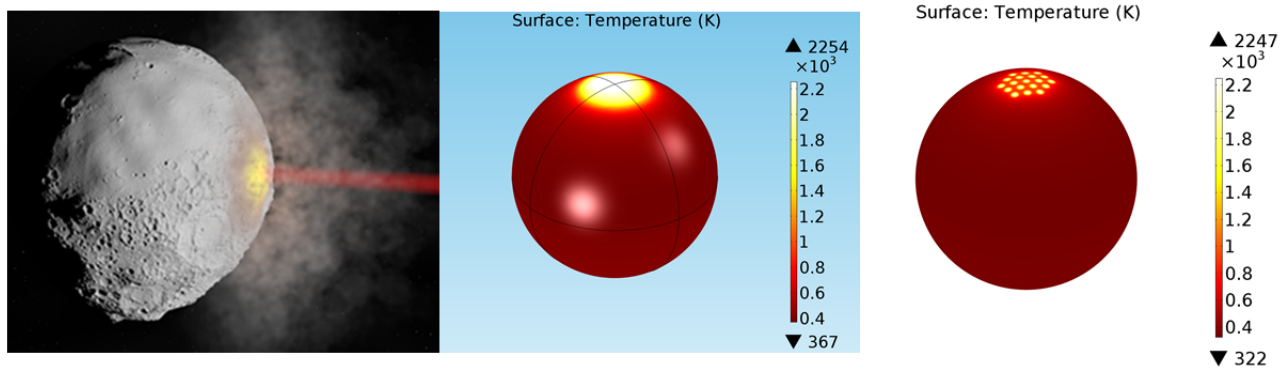

Figure 5. LEFT: Physics based simulation of asteroid laser ablation.² MIDDLE: Simulation showing one spot from the baseline phased array on the target at sufficient temperature to cause ablation. RIGHT: Multi-beam simulation depicting 19 beams on the target from an optional choice of a close packed laser array.

The proposed baseline optical system consists of 19 individual optical elements in a phased array. A single element concept is shown in Fig. 6. A significant benefit of utilizing an array of phase-locked laser amplifiers is that it is completely modular and thus scalable to much larger systems, and allows for a greater range than would a close packed array with a single optic. Focusing and beam steering are achieved by controlling the relative phase of individual laser elements. Rough pointing of the array to the target is determined by spacecraft attitude control and gimbaling of the optics. Laser tips behind each optical element are mounted on 6-axis micro-positioner hexapod; lateral movement of the laser tips behind each lens provides intermediate pointing adjustment for individual array elements. Each fiber tip is

supported on the hexapod and can be augmented with a z-axis rapid position controller if needed. It is not clear if this is needed currently. Precision beam steering is accomplished by coordinated phase modulation across the array by z-position control of the fiber tips as well as by electronic phase modulation. Each fiber is fed with a phase-controllable laser amplifier. Phase feedback from in front of the lens array to each phase controller provides a signal for beam formation adjustment (spot focus). Phase alignment is maintained to within $\lambda/10$ 1-sigma RMS across the entire array, assuming adequate phase controller system response⁹.

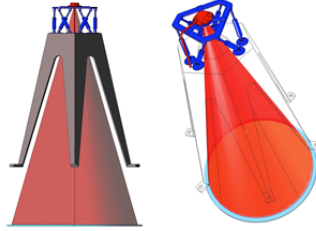

Figure 6. Single element of laser phased array.

The DE-STARLITE spacecraft will be capable of outfitting a laser array with an aperture between 1 m and 4.5 m. Changing the aperture would not change the power of the laser; thus the solar arrays and radiator could be of the same dimensions, regardless. The difference in mass between the 1 m array and the 4.5 m array is not significant enough to pose new constraints. The benefit of a larger aperture is that the range of the laser from the target for a given power scales with the linear size of the optical aperture. For example, the range of a 3 m array is three times greater than that of a 1 m array. The benefit of having a longer range is that it allows the spacecraft to remain clear of the debris of the ejected material. The debris flux ($\text{kg}/\text{m}^2\text{-s}$) that hits the spacecraft drops as the square of the distance to the target. However, the total amount of particle debris (kg/s) on the optic is independent of distance since the range is proportional to the optic diameter, and the area of the optic is proportional to the square of the diameter. The main drawback of the larger aperture is a higher associated cost. The decision, thus, is dependent on funding and other mission specifics. Even sub-meter diameter optics are feasible if needed for specific missions.

The laser array will be placed on a gimbal to eliminate any potential issues with fuel usage in maneuvering the spacecraft, as depicted in Fig. 7. Further, it will allow for much greater flexibility in mission execution. This is imperative because the laser will have to raster scan the asteroid in order to maximize thrust, prevent burn through, and de-spin the asteroid if needed. Though much of this can be done with electronic steering, using a gimbal will be more energetically efficient than pointing the spacecraft. A gimbal would also be beneficial in the event that the spacecraft needs to orbit the target. Further, the added flexibility due to the gimbal mitigates risk by allowing the system to target smaller pieces of the asteroid that may get dislodged and pose a threat to the spacecraft. The gimbal will allow for two degrees of freedom because the angular orientation around the boresight of the spot on the asteroid is not a significant concern. This will be cheaper, easier to manufacture, and lighter than a system with greater degrees of freedom.

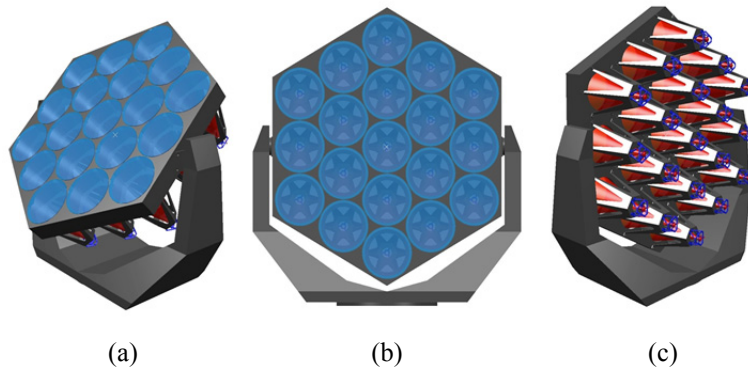

Figure 7. Mounted hexagonal laser phased array with a baseline of 19 elements depicted: **(a)** at 45 degrees, **(b)** face on, and **(c)** from the back.

Secondary Optical Arrangement - If necessary, a fallback option is to implement a hexagonal close packed focal plane array of laser fibers with a conventional optic such as a reflecting telescope instead of a phased array. A conceptual diagram is shown in Fig. 8. This system would consist of 19 circular fibers, each 25 μm in diameter with a sheath (cladding) around the inner core. The cladding will be 37.5 μm thick so that the center-to-center spacing of adjacent laser

fibers is 100 μm . The thickness of the cladding may be increased if power leakage is an issue. As with the phased array design, each fiber is attached to an amplifier; however, the fibers are close packed in the focal plane and utilize one larger hexapod and the lasers are NOT phase locked for simplicity. The close packed array will produce 19 individual spots on the target, separated center to center by the ratio of the target distance to optical size times the fiber spacing in the focal plane. For the baseline of 1.5 kW per amplifier, each fiber will illuminate the target with a spot diameter of approximately 12 mm and a center to center spacing of approximately 50 mm; however, this can be changed depending on the optical design. This option carries a lower risk, higher initial TRL, lower cost, and can also be implemented more rapidly. However, a significant drawback to the close packed fiber array is that it is not as scalable to larger DE-STAR systems. In addition, it requires the spacecraft to be significantly closer to the target than would be required with a phased array. The plan is to pursue both the phased array and the close packed array, and down select depending on specific mission parameters.

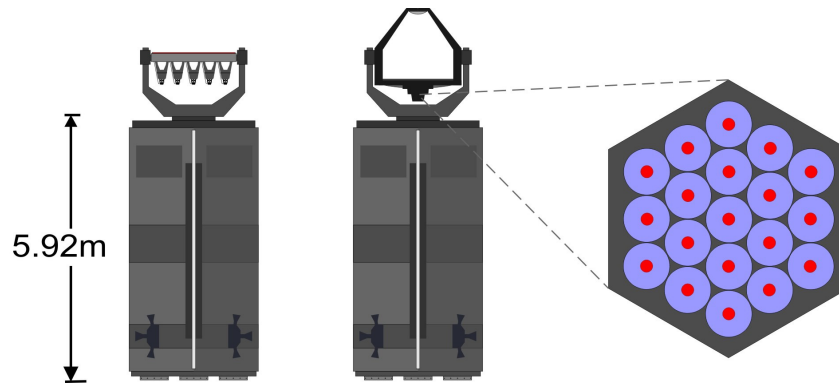

Figure 8. LEFT: Comparison view of mounted laser phased array and close packed array. **RIGHT:** Hexagonal close packed array of 19 laser fibers in the focal plane. Laser fibers have a diameter of 25 μm , the cladding around each of which is 37.5 μm thick.

2.4 Radiator

Thermal radiators are essential to spacecraft design so as to minimize incident radiation and maintain the spacecraft and its components at a functional temperature. The efficiency of the radiator can be determined by the equation:

$$F = \dot{Q}/A = \epsilon\sigma T^4 \quad (1)$$

where ϵ is the emittance of the surface, σ is the Stephan-Boltzmann constant, T is the temperature, \dot{Q} is the heat rejected, A is the area, and F is the flux¹⁰. The baseline radiator will be coated in AZ-93 white paint, which has a high emittance of 0.91 ± 0.02 (or conservatively, 0.89) and a low alpha, as it only absorbs 14 -16% of incident sunlight on the spacecraft. The goal is to maintain a temperature of 300 K, as both the laser and onboard control electronics are operational at this temperature. At this temperature, the radiator can reject an idealized outward flux of 408 W/m^2 . When taking into account the incident radiation, using a solar constant of 1,362 W/m^2 and a maximum 16% absorptance, the net flux of energy across the surface of the radiator is approximately 190 W/m^2 . The baseline is to prevent direct solar illumination of the radiator.

The area of the radiator must be determined by thermal analysis, and is dependent on the desired operating temperature, heating from the environment, interactions with other surfaces of the spacecraft (eg solar arrays), and the highest estimate (worst case) satellite waste heat. The waste heat in this case is dependent on the efficiency of the laser amplifiers—35%, 50%, or 70%, as mentioned. The worst-case estimate (35% efficiency) requires 65 kW to be rejected as waste heat for a 100 kw electrical input assuming virtually all the power goes to the laser (which is approximately correct during laser firing). The required area A can be easily determined:

$$\dot{Q}_{\text{rejected}} = AF_{\text{net}} \quad (2)$$

where F_{net} is the net outward flux and \dot{Q} is the heat rejected. Given these parameters, the maximum required area of the radiator is $\sim 341 \text{ m}^2$ for a 35% efficient laser amplifier. For a 50% efficient laser, a radiator area of $\sim 262.1 \text{ m}^2$ is required; for a 70% efficient laser, a radiator area of $\sim 157.2 \text{ m}^2$ is required.

A passive cooling z-folded radiator consisting of two deployable panels will be used in order to provide a sufficient surface area over which to emit the waste heat generated by the system. Each panel z-folds out into six segments, each of which further folds out into two additional segments, making 18 segments in total for each panel. The panels will rotate about their axes to maximize efficiency by remaining perpendicular to the sun and by radiating out of both sides. Each segment will be 2.2 m by 2.2 m, granting a total area of 348 m² out of which to dissipate heat. This will provide sufficient surface area to reject the maximum projected waste heat. If by the time of production, significant increases in laser efficiency have indeed been reached, the size of the panels can be altered so as to reduce the excess mass if less heat needs to be dissipated. Sun shades may also be employed to limit solar absorption and thus allow for greater efficiency. The current mass to power ratio for radiators is about 25 kg/kW for the ARM system.

3. LAUNCH SYSTEM

The objective is to assess which launch vehicle is the most feasible and will provide the greatest performance given the mission directives of DE-STARLITE. The launch systems in consideration are Atlas V 551, Space Launch System (SLS) Block 1, Falcon Heavy, or Delta IV Heavy. These are likewise the launch systems in consideration for JPL’s Asteroid Redirect Mission, which calls for a payload of comparable parameters¹¹.

Table 1. Parameters of various launch vehicles in consideration for DE-STARLITE

Parameter	Atlas V 551	SLS Block 1	Falcon Heavy	Delta IV Heavy
Payload Mass to LEO	18,500 kg	70,000 kg	53,000 kg	28,790 kg
Cost per unit mass to send into LEO	\$13,182 / kg	\$18,739 / kg	\$1,890 / kg	\$13,026 / kg
Diameter of Payload Fairing	5.4 m	8.4 m	5.2 m	5 m
Status	Flight proven	Development— First Expected Flight: 2017	Development— First Expected flight: 2015	Flight proven

The DE-STARLITE spacecraft will fit within the payload fairing of any of the proposed launch systems, as depicted in Fig. 9. As is evident from the data in Table I, the SLS Block 1 has the highest capabilities, though also requires the highest cost. The Falcon Heavy demands the smallest cost per unit mass, and has capabilities between that of the Atlas V and SLS Block 1. While the Atlas V 551 and Delta IV Heavy have previously undergone successful missions, the SLS Block 1 and Falcon Heavy are projected to be flight-proven within the timescale of the DE-STARLITE mission. As with the Asteroid Redirect Mission, it is possible to compensate for the lower capabilities of the Atlas V by using the SEP system to spiral out of Earth’s orbit and escape from Earth using Lunar Gravity Assist (LGA); however, this process of spiraling out and using LGA will take an additional 1 – 1.5 years of flight. All of these factors must be taken into consideration to choose the most effective launch system for the DE-STARLITE mission.

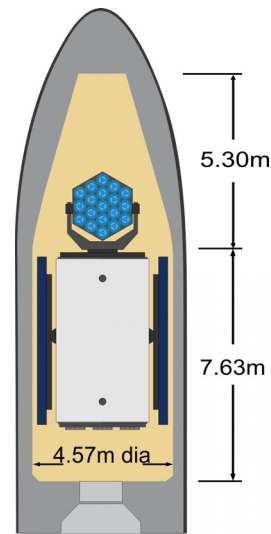

Figure 9. Stowed view of the DE-STARLITE spacecraft.

4. ORBITAL DEFLECTION CAPABILITIES

4.1 How magnitude and duration of applied thrust influence miss distance

When an asteroid is exposed to the DE-STARLITE laser, the temperature [K] and flux [W/m²] on the target asteroid must approach sufficiently high levels in order for significant ablation to occur, targeting a temperature on the order of 3,000 K and a flux of >10⁷ W/m². This causes direct evaporation of the asteroid at the spot of contact. Evaporation at the spot produces a vaporization plume thrust [N] that can be used to change the asteroid’s orbit and effectively deflect asteroids from colliding with Earth. A miss distance of at least two Earth radii (12,742 km) is required

to eliminate the threat of collision. The orbital deflection depends on the duration, magnitude, and direction of the applied thrust.

A three-body simulation (accounting for the gravitational effects of the Earth, the sun, and the target asteroid) was performed in order to analyze how the applied thrust and the laser-active time impact the miss distance. In order to determine the orbital deflection, Δx , of an asteroid that is being acted on over a period of time, t , an approximation that is commonly used in orbital mechanics was used as a comparison. The detailed numerical simulation is compared to the approximation of multiplying by 3 the naive distance achieved by accelerating and coasting a system that is not a bound gravitational system. Hence the orbital deflection is compared to:

$$\Delta x_{\text{approx}} = 3(0.5 a \cdot t_{\text{active}}^2 + a \cdot t_{\text{active}} \cdot t_{\text{coast}}) \quad (3)$$

where a is the acceleration caused by the plume thrust, t_{active} is the time the laser is active, and t_{coast} is the coast time (typically zero). The reason this is done is because this approximation is often used for preliminary mission design.

The numerical simulations were performed in a rotating frame, where the thrust was pointed both along and against the velocity vector for comparison. Many dozens of orbital simulations were analyzed. The first data set shown compares the laser-active time to the miss distance for a given thrust acting on targets of varying diameter. This paper focuses on the 325 m diameter asteroid case, as this is approximately the size of Apophis—a well-known possible threat. Computations have also been done for 20 to 1,000 m asteroids under many mission scenarios. The same code is used to analyze the IBD, gravity tractor and impactor (impulse) cases to which DE-STARLITE are compared. A sample of the results for the 325 m asteroid case is displayed in Fig. 10. It is evident that the factor-of-three approximation is indeed only an approximation and in some cases fails badly.

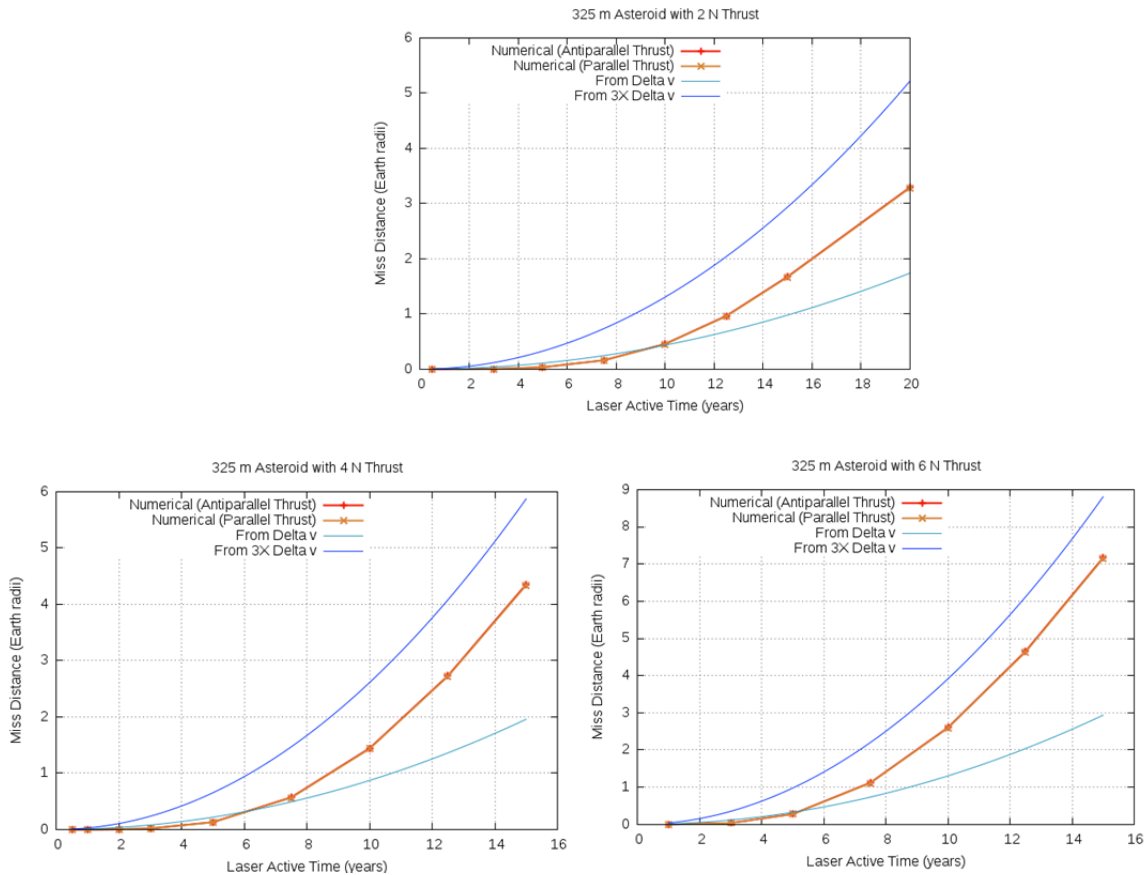

Figure 10. Plots of miss distance vs. laser-active time for an Apophis-sized asteroid (325 m) subject to a thrust of 2N, 4N, and 6N, respectively. These thrusts should be achievable with this system.

Fig. 11 displays the trajectory of the Earth relative to that of a 325 m asteroid subject to varying magnitudes of thrust over a period of 15 years. The dot at the point of intersection indicates a point of impact; collision will occur if only one Newton of force is applied. However, although the trajectories still appear to cross in the time-lapse plot, the asteroid

and the Earth will not reach the point of intersection at the same time if the asteroid is subjected to a force of greater magnitude. Thus, no collision will occur if the system provides sufficient thrust. If the laser is active for 15 years and provides ~2 N of thrust, the asteroid will miss the earth by two Earth radii, and if 10 N of thrust is provided over this same period, the asteroid will avoid impact by 13 Earth radii.

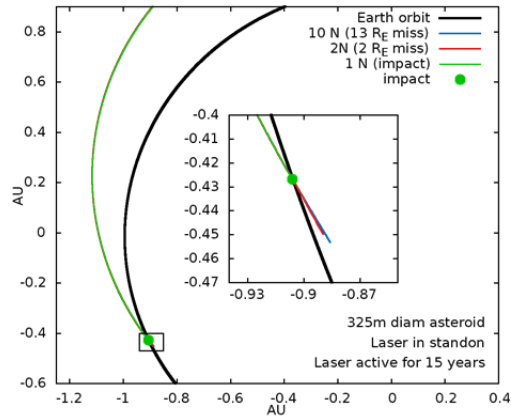

Figure 11. Trajectory of the Earth compared to that of a 325 m asteroid subject to 1N, 2N, and 10N of thrust over a period of 15 years.

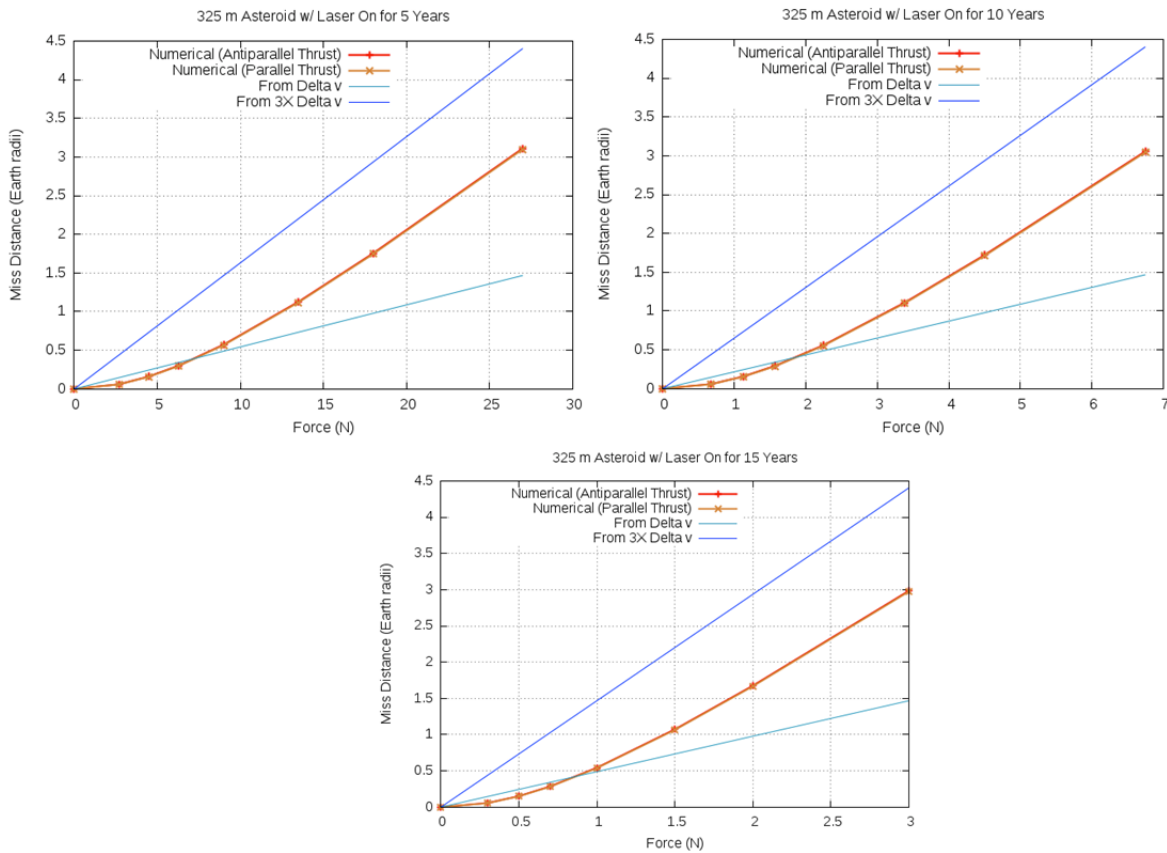

Figure 12. Plots of miss distance vs. thrust for an Apophis-sized asteroid (325 m) over a period of five years, ten years, and fifteen years, respectively. It is clear that operating over a longer period of time (longer warning time) greatly simplifies the system requirements in terms of thrust needed and power required.

Further, for a given period of time, the required force is compared to the miss distance for targets of varying diameter. Simulations were run for targets of diameters between 20 m and 1000 m for varying mission parameters. Again, a sample of this data is displayed in Fig. 12 for a 325 m asteroid.

As is evident in Fig. 10 and Fig. 12, applying a thrust either parallel or antiparallel to the motion of the asteroid produces an equivalent deflection (but misses on opposite side of the Earth's orbit). Numerical analysis suggests that applying a thrust of 2.3 N over a period of 15 years will allow a 325 m asteroid to miss the Earth by two Earth radii. In contrast, if the laser were active for ten years, it would require approximately 5 N of force to deflect a 325 m asteroid by two Earth radii, and if it were only active for five years, it would require nearly 20 N of thrust to produce a comparable result.

4.2 How optics diameter, distance from the target, and laser power effect the flux on the target

For a laser phased array of a given power, a larger aperture enables the spacecraft to be further from the target while still producing sufficient ablation. The ratio of power to spot area must remain $>10^7 \text{ W/m}^2$ in order for significant ablation to occur for high temperature compounds. Comets take much less flux due to their high volatility. With 35 kW of optical output, a laser phased array with a 4.5 m aperture can provide sufficient ablation from an approximate distance of 125 km, whereas a 35% efficient laser phased array with a 1 m aperture must be within 28km of the target. Increased efficiency of the laser amplifiers will provide for even greater range. At 50% efficiency, with 50 kW of optical output, a 4.5 m laser array will have a range of approximately 150 km, while a 1 m array will have a range of roughly 33 km. Several cases are shown in Fig. 13.

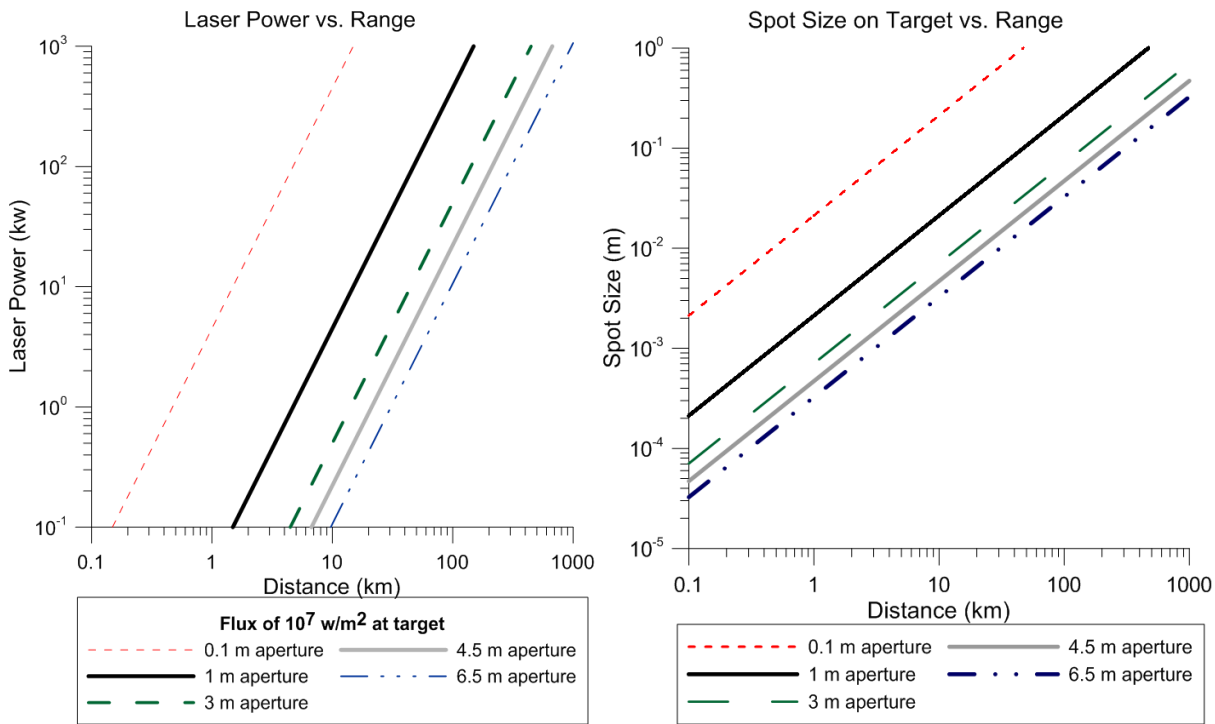

Figure 13. LEFT: Plot of laser power vs. range for various apertures. For the phased array, the relevant laser power is the sum of all the laser power, while for the close packed fiber array it is the power of EACH individual laser. RIGHT: Spot size vs. range for various apertures. The spot size on the target is approximately independent of whether a phased array or a close packed fiber array is used. It basically only depends on the aperture size and wavelength for a diffraction limited system.

For the close packed array alternative, the product of the optical diameter and the ratio of the spot sigma to the focal plane sigma provides an estimate for the target range. If a 1 m diameter optical system is implemented with a 2 mm spot sigma and 4 μm focal plane sigma, a range of 0.5 km can be achieved. Given the same parameters, a 4.5 m optical system will have a range of 2.3 km—much closer than with the phased array.

4.3 Comparison of efficiency of laser ablation versus ion beam deflection (IBD)

Ion beam deflection (IBD) is an alternative approach to achieve asteroid orbital deflection in which an ion beam is used to push against the asteroid. In using this approach, the spacecraft must provide twice as much thrust as would otherwise be necessary to deflect the asteroid a desired distance. Half of the thrust is lost in station keeping in order to keep the spacecraft stable, as the spacecraft must push towards or away from the asteroid with an equal amount of thrust.

The mass required (Δm) for a desired impulse (Δp) is determined by the following succession of equations. The force F is given by,

$$F = \frac{dm}{dt} V_{rel} \quad (4)$$

where v_{rel} is the exhaust velocity. The desired impulse is

$$\Delta p = F \Delta t = \frac{dm}{dt} v_{rel} \Delta t = (\Delta m) v_{rel} \quad (5)$$

which can be solved to find the mass required for a desired impulse,

$$\Delta m = \frac{\Delta p}{V_{rel}} \quad (6)$$

The mass of propellant needed to produce an impulse of Δp on an asteroid using ion beam deflection is given by the equation:

$$\Delta m = 2 \frac{\Delta p}{V_{rel}} \quad (7)$$

where the factor of two accounts for half of the thrust being used to stabilize the spacecraft. Using the IBD approach, the magnetically shielded Hall thruster is essentially reduced from $40 \mu\text{N}/\text{W}_{\text{elec}}$ to $20 \mu\text{N}/\text{W}_{\text{elec}}$ effective on the asteroid. Using Xenon as a propellant, the exhaust speed is effectively 30 km/s for a Hall effect thruster with an I_{sp} of 3000s. As a baseline example, to deflect an Apophis-sized asteroid (325 m) a miss distance of two Earth radii requires 2.3 N of thrust over a period of 15 years. According to the above equations, this action would require $\sim 72,300$ kg of Xenon. An additional 5% of this mass is required to account for the tanks needed to hold the propellant, thus totaling 75,900 kg. If gridded ion thrusters with an I_{sp} of 6000 s are employed, which may be the case for a dedicated IBD mission, the mass of propellant required to produce a given thrust would be cut in half as the exhaust velocity is twice as great. While a significant amount of propellant is required to deflect an asteroid using the IBD method, no extra propellant is necessary after rendezvous with the asteroid (which uses a small amount of propellant from LEO) for the laser ablation case. A significant benefit of using laser ablation is that the asteroid is propelled by the ejection of its own material and thus the asteroid is itself the fuel. The mass of the laser array and the increased mass of the radiator (because the ion engines have a greater efficiency than the laser amplifiers) required for the laser ablation approach are of a far lesser magnitude than the additional mass of fuel needed for the IBD approach. Laser ablation is therefore proposed to be a more efficient mechanism by which to deflect an asteroid.

A laser ablation system such as the proposed DE-STARLITE system is much lower in mass than an equivalent IBD system. The following data presents preliminary mass estimates that should be treated as such. With roughly 7 tons to LEO, a DE-STARLITE spacecraft could accommodate 100 kW of electrical input, which corresponds to 50 kW of optical output (assuming 50% laser amplifier efficiency). The resulting effective thrust on the target is 2.5 N, given an effective thrust per electrical watt of $25 \mu\text{N}/\text{W}_{\text{elec}}$. This assumes 50% laser efficiency, 70% of the optical power in the central spot (encircled energy) and $80 \mu\text{N}/\text{W}_{\text{optical}}$ for the laser-asteroid coupling. The simulations predict up to 5 times this amount; however, a conservative value is assumed here. Applying this amount of thrust over a period of 15 years would result in the orbital deflection of a 325 m asteroid by over two Earth radii. To produce the same result using IBD requires $\sim 79,900$ kg (75,900 kg for the propellant and tanks, as described above, as well as approximately 4000 kg for the dry mass of the spacecraft) if using magnetically shielded Hall effect thrusters, or $\sim 42,000$ kg (approximately 38,000 kg for propellant and tanks in addition to the dry mass of the spacecraft) if using gridded ion thrusters with an I_{sp} of 6000 s. Note the higher I_{sp} (6000 s) ion engine requires about twice the power of the lower I_{sp} (3000 s) ARM engine for the same thrust. A trade study needs to be done to optimize this.

In comparing the systems, the extra ion engine fuel needed to deflect an asteroid could be instead used to massively increase the PV arrays and thus provide even more power to the laser system. Given 14 tons to LEO, a spacecraft utilizing IBD with Hall effect thrusters is estimated to be capable of outfitting 40 kW of electrical input, whereas a spacecraft utilizing laser ablation would be capable of supporting approximately 380 kW of electrical power

by redistributing the mass. This corresponds to 190 kW of optical output for laser amplifiers operating at 50% efficiency, or a thrust on the target of approximately 9.5 N—enough thrust to deflect a 250 m asteroid by a miss distance of two Earth radii over a period of five years. Thus with the same mass as a spacecraft that would be used to capture a 5-10 m asteroid, a system using laser ablation could protect the Earth from catastrophic devastation.

For a given power, the mass of the spacecraft utilizing laser ablation is approximately independent of the diameter of the target asteroid. Though the laser must be active for more time to deflect an asteroid of larger diameter, it does not require more mass to do so. In contrast, the mass of a spacecraft utilizing IBD increases as the cube of the asteroid diameter in order to accommodate more propellant to provide sufficient integrated thrust. Increasing the power output of the system will decrease the required warning time for a target of a given diameter because it will lessen the required laser-active time. Several warning-time scenarios are depicted in Fig. 14. The DE-STARLITE mission calls for a baseline of 100 kW electrical, though this could be increased while staying within the mission parameters in order to decrease the required warning time. ATK has a path forward to 30 m diameter class arrays that would yield in excess of 400 kW of electrical power per pair. This path is consistent with the launch capabilities of the launch vehicles under consideration for the DE-STARLITE mission.

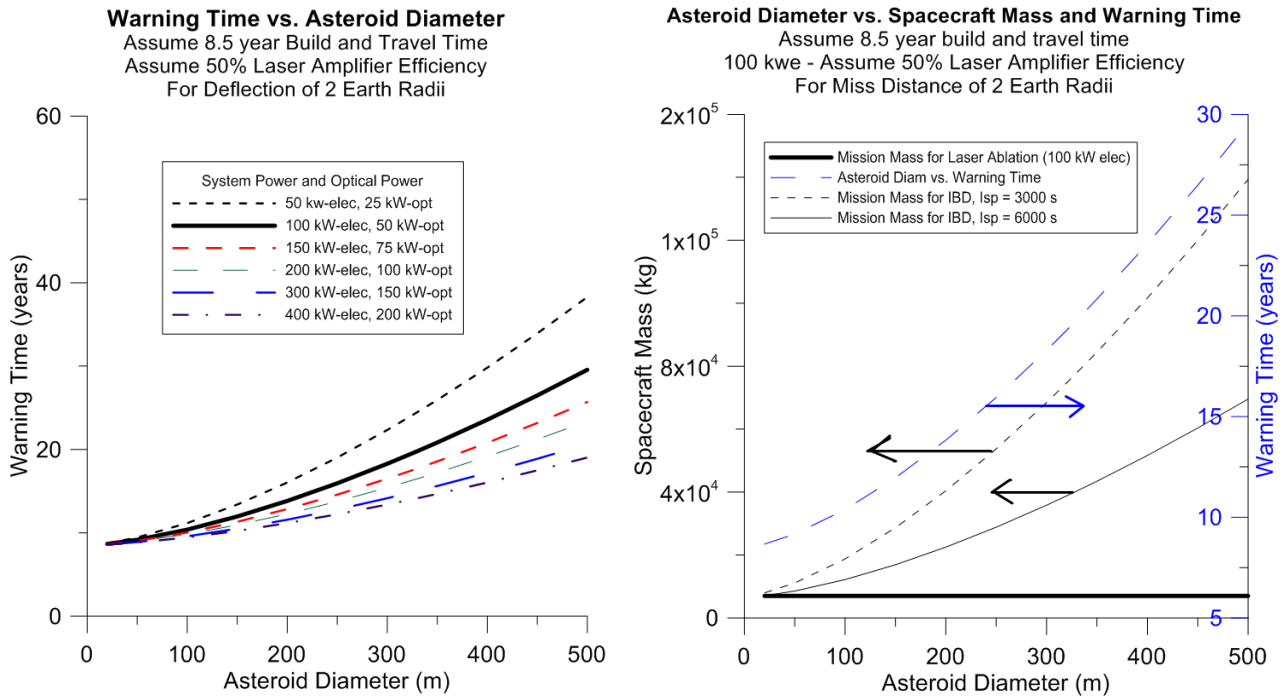

Figure 14. LEFT: Warning time versus asteroid diameter to produce a two Earth radii deflection for various system and optical powers assuming a laser amplifier efficiency of 50%, an 8.5 year build and travel time and an asteroid density of 2 g/cc. **RIGHT:** Asteroid diameter vs spacecraft mass (left axis) for the IBD case (utilizing both magnetically shielded Hall effect thrusters with an I_{sp} of 3000s, and gridded ion thrusters with an I_{sp} of 6000s) and for laser ablation, as well as asteroid diameter vs the required warning time for a laser ablation system with 100 kw electrical power (right axis). For an equivalent warning time, the IBD case with an I_{sp} of 3000s requires ~125 kW electrical power, and the IBD case with an I_{sp} of 6000s requires ~250 kW electrical power. The same parameters (8.5 year build and travel time, 50% efficient laser amplifiers, 2g/cc and 2 Earth radii miss distance) are assumed. Note that the 8.5 year build and travel time is assumed for a spacecraft using ion engines with an I_{sp} of 3000s; the travel time may be decreased with ion engines of greater specific impulse and efficiency.

5. CONCLUSIONS

DE-STARLITE is a very promising planetary defense system at a modest cost. As outlined above, DE-STARLITE employs laser ablation technologies which use the asteroid as the "fuel" for its own deflection, and thus is able to mitigate much larger targets than would be possible with other proposed technologies such as IBD, gravity tractors, and kinetic impactors. For instance, with the equivalent mass of an ARM Block 1 arrangement (14 tons to LEO), designed to capture a 5-10 m diameter asteroid, DE-STARLITE can mitigate an asteroid larger than Apophis (325

m diameter), even without keyhole effects. Much smaller DE-STARLITE systems could be used for testing on targets that are likely to pass through keyholes. The same technology proposed for DE-STARLITE has significant long-range implications for space missions, as outlined in other DE-STAR papers. Among other benefits, the DE-STARLITE system utilizes rapidly developing technologies to perform a task previously thought to be mere science fiction and can easily be increased or decreased in scope given its scalable and modular nature. DE-STARLITE is capable of launching on an Atlas V 551, Falcon Heavy, SLS, Ariane V or Delta IV Heavy, among others. Many of the items needed for the DE-STARLITE system currently have high TRL; however, one critical issue currently being worked on is the radiation hardening of the lasers, though it appears achievable to raise this to a TRL 6 within 3-5 years. Laser lifetime also poses an issue, though this is likewise being worked on; a path forward for continuous operation looks quite feasible, with or without redundancy options for the lasers. Given that the laser amplifier mass is small and the system is designed to take multiple fibers in each configuration, redundant amplifiers can be easily implemented if needed. DE-STARLITE is a critical step towards achieving the long-term goal of implementing a standoff system capable of full planetary defense and many other tasks including spacecraft propulsion. DE-STARLITE represents a practicable technology that can be implemented within a much shorter time frame at a much lower cost. DE-STARLITE will help to establish the viability of many of the critical technologies for future use in larger systems.

ACKNOWLEDGEMENTS

We gratefully acknowledge funding from the NASA California Space Grant NASA NNX10AT93H in support of this research.

REFERENCES

- [1] Riley, J., Lubin, P., Hughes, G.B., O'Neill, H., Meinhold, P., Suen, J., Bible, J., Johansson, I.E., Griswold, J. and Cook, B. "Directed energy active illumination for near-Earth object detection," *Nanophotonics and Macrophotonics for Space Environments VIII*, edited by Edward W. Taylor, David A. Cardimona, Proc. of SPIE Vol. 9226 (Aug, 2014).
- [2] Lubin, P., Hughes, G.B., Bible, J., Bublitz, J., Arriola, J., Motta, C., Suen, J., Johansson, I., Riley, J., Sarvian, N., Clayton-Warwick, D., Wu, J., Milich, A., Oleson, M., Pryor, M., Krogen, P., Kangas, M., and O'Neill, H. "Toward Directed Energy Planetary Defense," *Optical Engineering*, Vol. 53, No. 2, pp 025103-1 to 025103-18 (2014), doi: 10.1117/1.OE.53.2.025103.
- [3] Apgar, H. et al, [Space Mission Engineering: The New SMAD], Microcosm Press, Hawthorn, 663-700 (2011).
- [4] Patel, P., Aiken, D., Chumney, D., Cornfield, A., Lin, Y., Mackos, C., McCarty, J. Miller, N., Sharps, P., Stan, M., "Initial Results of the Monolithically Grown Six-Junction Inverted Metamorphic Multi-junction Solar Cell", 38th Photovoltaics Specialist Conference, 2 (2013).
- [5] Murphy, D., Eskenazi, M., Spink, J., McEachen, M., Trautt, T., McClenathan, M., Menna, M., Nielson, R., Sorensen, P., "ATK MegaFlex Solar Array Development and Test", Space Power Workshop, 1-46 (2014).
- [6] Rogers, D., Brophy, J., "Ion Propulsion Technology for Fast Missions to Pluto," IEPC-01-179.
- [7] Johansson, I.E., Tsareva, T., Griswold, J., Lubin, P., Hughes, G.B., O'Neill, H., Meinhold, P., Suen, J., Zhang, Q., J., Riley, J. Walsh, K., Brashears, T., Bollag, J., Mathew, S. and Bible, J. "Effects of asteroid rotation on directed energy deflection," *Nanophotonics and Macrophotonics for Space Environments VIII*, edited by Edward W. Taylor, David A. Cardimona, Proc. of SPIE Vol. 9226 (Aug, 2014).
- [8] Hughes, G.B., Lubin, P., Griswold, J., Bozinni, D., O'Neill, H., Meinhold, P., Suen, J., Bible, J., Riley, J., Johansson, I.E., Pryor, M. and Kangas, M. "Optical modeling for a laser phased-array directed energy system (Invited Paper)," *Nanophotonics and Macrophotonics for Space Environments VIII*, edited by Edward W. Taylor, David A. Cardimona, Proc. of SPIE Vol. 9226 (Aug, 2014).
- [9] Hughes, G.B., Lubin, P., O'Neill, H., Meinhold, P., Suen, J., Riley, J., Johansson, I. E., Bible, J., Bublitz, J., Arriola, J., Motta, C., Griswold, J., Cook, B., Sarvian, N., Clayton-Warwick, D., Wu, J., Milich, A., Oleson, M., Kangas, M., Pryor, M. and Krogen, P. "DE-STAR: phased-array laser technology for planetary defense and exploration," *STAR DUST 1st Stardust Global Virtual Workshop (SGVW-1) on Asteroids and Space Debris*, Conference Proceedings edited by Massimiliano Vasile (May, 2014).
- [10] Aaron, K. *et al.*, [Spacecraft Thermal Control Handbook, Volume 1: Fundamental Technologies], The Aerospace Press, El Segundo, ch. 6 (2002).
- [11] Brophy, J., Muirhead, B. "Near-Earth Asteroid Retrieval Mission (ARM) Study," 33rd *International Electric Propulsion Conference* (2013).